

Effect of Wi-Fi exposure and edible bird nest supplementation on the testicular oxidative stress status and sperm quality in male Sprague-Dawley rat pups

F.H.F. Jaffar¹, K. Osman², C.K. Hui¹, A.F. Zulkefli¹, S.F. Ibrahim^{1*}

¹Department of Physiology, Faculty of Medicine, Universiti Kebangsaan Malaysia (UKM), Jalan Yaacob Latif, Bandar Tun Razak, Cheras, Kuala Lumpur 56000, Malaysia

²Forensic Science Program, Centre for Diagnostic Science & Applied Health, Faculty of Health Sciences, Universiti Kebangsaan Malaysia (UKM), UKM Bangi, Selangor 43600, Malaysia

ABSTRACT

► Original article

***Corresponding author:**
Siti Fatimah Ibrahim, Ph.D.,
E-mail: timi@ukm.edu.my

Received: May 2023

Final revised: September 2023

Accepted: November 2023

Int. J. Radiat. Res., April 2024;
22(2): 329-338

DOI: 10.61186/ijrr.22.2.329

Keywords: IMRT, OARs, TPS, DVH, mixed energy plans.

Background: Wireless Fidelity (Wi-Fi) exposure might induce tissue damage through non-thermal effects. Nonetheless, only a few studies have evaluated the non-thermal effects on the testis undergoing reproductive development following Wi-Fi exposure. This study aimed to assess the oxidative stress status in the testis and subsequent sperm quality of growing rat pups that received edible bird nest (EBN) supplementation simultaneously. **Materials and Methods:** Fourteen weeks of 2.45GHz Wi-Fi exposure and simultaneous 250mg/kg EBN were supplemented to three-week-old male Sprague–Dawley rats. Thirty animals were divided equally into control, control EBN, Wi-Fi, sham Wi-Fi, and Wi-Fi+EBN. **Results:** Results showed an increase in total oxidant status (TOS), a significant decrease in total antioxidant status (TAS), and a significant increase in the expression of 8-hydroxy-2'-deoxyguanosine (8-OHdG) in the testis of the Wi-Fi group. Sperm chromatin integrity, morphology, concentration, and motility were among the parameters that significantly decreased. Supplementation of 250mg/kg EBN in the Wi-Fi+EBN group significantly reduced TOS and 8-OHdG expression in the testis. EBN supplementation also significantly increased sperm chromatin integrity, morphology, and concentration. **Conclusion:** Wi-Fi exposure induces oxidative stress in the testis and affects important sperm parameters in rat pups. EBN supplementation quenched the oxidative stress activity due to Wi-Fi exposure and improved sperm quality.

INTRODUCTION

Wireless Fidelity (Wi-Fi) has evolved into a necessary element that seamlessly integrates into modern living. This technology uses radiofrequency radiation (RFR) to enable data transfer during wireless communication while operating under an unlicensed 2.45 GHz frequency band ⁽¹⁾. As a result of its flexibility, Wi-Fi has been widely used to carry out daily tasks and activities. Thus, excessive Wi-Fi unintentionally adds to the surrounding electro-smog or electro-pollution ⁽²⁾. Recently, this awareness has started to cause public concern.

Wi-Fi exposure can lead to pathological issues through both thermal and non-thermal effects ⁽³⁾. The thermal effect causes localized tissue temperature to rise. Given that the testis is one of the organs susceptible to temperature changes, an increase in testicular temperature would cause spermatogenesis to be disrupted ⁽⁴⁾. In our previous report, we demonstrated that Wi-Fi exposure causes a decrease in spermatogonia mitotic activity when Sprague-Dawley pups are exposed to Wi-Fi until adulthood ⁽⁵⁾.

The spermatogonia mitosis phase during spermatogenesis is important in determining the number of spermatozoa that will be produced ⁽⁶⁾. Given that spermatogonia mitosis is impaired following Wi-Fi exposure ⁽⁵⁾ and causes disruption of spermatogenesis, subsequent sperm yields may decrease. Thus, the purpose of this study was to assess sperm quality including sperm concentration, motility, viability, morphology, and chromatin integrity after prolonged Wi-Fi exposure.

The participation of reactive oxygen species (ROS), which contributes to oxidative stress, is thought to be responsible for the non-thermal effect ⁽⁷⁾. This hypothesis is supported by several scientific papers that reported an increase in malondialdehyde (MDA), total oxidant status (TOS) ⁽⁸⁾, and level of serum and testicular 8-hydroxy-2'-deoxyguanosine (8-OHdG) ⁽⁹⁾ following Wi-Fi exposure toward male albino rats.

Interestingly, no available studies have reported the oxidative stress status in the testis during reproductive development. Therefore, this current study aimed to evaluate the oxidative stress status in

the testis of growing Sprague Dawley pups that received long-term Wi-Fi exposure. We adopted protocols of Wi-Fi exposure similar to those in our previous report (5). This approach was chosen to emulate how children, who comprise a significant portion of Wi-Fi users worldwide, are affected by Wi-Fi exposure (10).

On the basis of the above discussion, Wi-Fi exposure would likely disrupt the production of sperm quality through the oxidative stress pathway. Thus, mitigation by using an antioxidant supplement would be necessary.

Edible bird's nest (EBN) was chosen as it contains antioxidative properties (11,12). EBN is made from the saliva of a male swiftlet (*Aerodramus fuciphagus*) especially during the breeding season (13). Primarily found in Southeast Asian countries (14), EBN has been reported to have a positive proliferative effect and contains reproductive hormone (5). These characteristics are crucial for improving the reproductive system. We have already examined the proliferative and hormonal effects of EBN, so this study focuses on its antioxidant properties. Here, this study postulated that EBN supplementation may offer protection against oxidative stress following Wi-Fi exposure and, therefore, improve sperm quality.

Hence, an additional goal of this study was to evaluate EBN's protective effect on testicular oxidative stress status and sperm parameters that may develop following Wi-Fi exposure in the testis of growing rat pups. Exploration of EBN's potential to enhance male fertility status, especially in the young, are imperative (5).

Similar studies that provide an antioxidant approach to attenuate the Wi-Fi exposure effect have been reported (15-17). However, EBN has more than an antioxidant approach as its constituent can potentially enhance spermatogenesis because of its proliferative and hormonal activity. Yet, no study has reported the potential of EBN to attenuate oxidative stress particularly against Wi-Fi exposure in young testis. Thus, this study adopted this approach with further hopes that EBN supplementation may provide an alternative option in treating males with fertility issues, particularly in the era of wireless communication.

MATERIALS AND METHODS

The Wi-Fi exposure and supplementation of EBN methods used in this study were the same as those used in our earlier report by Jaffar *et al.* (5, 18). The technique used is briefly outlined below.

Animals

Thirty (N=30) 3-week-old male Sprague-Dawley rats weighed around 45 ± 5 g were obtained from the Laboratory Animal Research Unit National University

of Malaysia. All the rat pups were divided randomly into five groups with six animals (n=6) in each group. The details of each group are described in Table 1. All animals were free to move individually inside a cage (29 cm in height \times 43 cm in length \times 16 cm in width) without any movement restriction (5).

Table 1. Description of the experimental group (5).

Group	Description
Control	No Wi-Fi exposure from a Wi-Fi router + normal food pellet
Control EBN	No Wi-Fi exposure from a Wi-Fi router + 250 mg/kg EBN-enriched food pellet
Wi-Fi	Wi-Fi exposure from an active Wi-Fi router + normal food pellet
Sham Wi-Fi	Exposure from an inactive Wi-Fi router + normal food pellet
Wi-Fi+EBN	Wi-Fi exposure from an active Wi-Fi router + 250 mg/kg EBN-enriched food pellet

All the animals were kept in a room with 12 h light: dark cycle with the ambient temperature of 22 ± 5 °C and provided with clean water *ad libitum*. All animal procedures were ethically approved by the National University of Malaysia Animal Ethical Committee (UKMAEC) on March 28, 2018. This study's animal ethical approval reference number was FISIO/PP/2018/SITI FATIMAH/28-MAR./908-MAR.-2018-DEC.-2020 (5).

Wi-Fi exposure setting

A similar Wi-Fi exposure setting was applied as in our previous report [5]. A TP-LINK AC750 Wireless Dual Band Wi-Fi Router Archer C20 (Shenzhen, China), which emits 2.45 GHz Wi-Fi frequency, was placed at a 20 cm distance from the animal cages (figure 1).

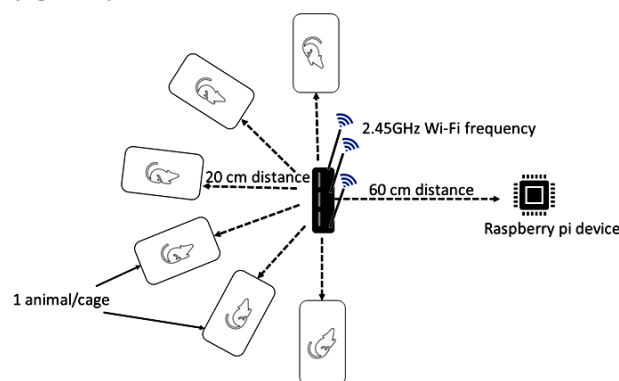

Figure 1. Wi-Fi exposure setting where a Wi-Fi router was placed 20 cm from the animal cages and a Raspberry Pi device was placed 60 cm away from the router. All animals were caged individually, were allowed to move freely within the cage and received 24 h of Wi-Fi exposure for 14 consecutive weeks.

The Wi-Fi group was exposed to a router maintained in an active state by constantly pinging a Raspberry Pi device (Raspberry Pi Foundation, the UK) at 10 pings/min through Bitwise SSH client software version 8.18 (Bitwise Limited, USA). By

contrast, the sham Wi-Fi group only received exposure from the Wi-Fi router without the ping. This simulated an inactive state. Exposure to Wi-Fi was conducted 24 h daily for 14 consecutive weeks.

Supplementation of edible bird nest (EBN)

The source of EBN used in this study was similar to that reported in our preliminary study⁽¹⁸⁾. In short, the raw EBN was harvested from the swiftlet's house in Bera, Pahang, Peninsular Malaysia, which was then cleaned and extracted by freeze-dry method by Glycofood Sdn. Bhd.

The dose of 250 mg/kg EBN applied in this study was chosen because daily supplementation of 250 mg/kg EBN had shown a significant increase in sperm concentration, percentage of sperm motility, and follicle stimulating hormone (FSH) and luteinizing hormone (LH) levels⁽¹⁸⁾.

EBN supplementation was carried out via natural feeding by enriching the food pellet with EBN extract powder. Details of the calculation to provide the daily EBN dosage were reported by Jaffar *et al.*⁽¹⁸⁾.

Animal Euthanasia and Tissue Sampling

Following 14 weeks of Wi-Fi exposure and EBN supplementation, each animal was euthanized with a ketamine (Ilium, USA)-tiletamine (Ilium, USA)-xylazine (Virbac, French) cocktail intraperitoneally. The right testis was harvested and fixed in 10% buffered neutral formalin (Merck, Germany), processed with standard tissue preservation protocol, and embedded in paraffin wax (Merck, Germany). This right testis was used for immunofluorescence staining to evaluate the expression of 8-OHdG. The left testis was snap-frozen and stored at -80°C until analysis. A portion of this left testis was used to create homogenate, which was then used to assess the overall oxidative and antioxidant status of the testis.

For the analysis of sperm parameter, epididymal sperm were collected from the cauda epididymis. The cauda epididymis was dissected, minced into small pieces, and incubated at 37°C for 40 min in 2 mL of pre-warmed phosphate buffered saline (PBS) (ThermoFisher Scientific, USA).

Total oxidant status (TOS) and total antioxidant status (TAS) in testis homogenate

To measure TOS and TAS in the testis, 10 mg of snap-frozen testicular tissue was homogenized using 1 mL of 0.2 mM (pH 7.4) Tris-HCl (Sigma Aldrich, Germany) buffer at a cold temperature⁽¹⁹⁾. TOS and TAS were measured using the TOS assay kit and the TAS assay kit (Diagnostic Assay Rail, Turkey), respectively. Preparation of tissue homogenates and TOS and TAS measurements were performed based on the guidelines from the TOS and TAS assay kits.

In this work, 10 $\mu\text{mol/L}$ hydrogen peroxide (H_2O_2 ; Diagnostic Assay Rail, Turkey) was provided as a

standard solution for the TOS assay. About 45 μL of this standard solution or sample was added to a 96 well plate in duplicate, followed by adding 300 μL of Reagent 1 containing 25 mM sulfuric acid (H_2SO_4 , pH of 1.75; Diagnostic Assay Rail, Turkey). The first absorption (P1) was read using a SpectraMax Plus 384 Microplate spectrophotometer (Molecular Devices, CA, USA) machine at 530 nm. Subsequently, 15 μL of Reagent 2 containing 25 mM H_2SO_4 (pH 1.75), 5 mM ferrous ions and 10 nM O-dianisidine (Diagnostic Assay Rail, Turkey) was added to each well. The second absorption (P2) was read after 10 min of incubation at room temperature. The absorption of each sample was then calculated by using formula 1. Subsequently, the TOS of each sample was calculated according to formula 2 and reported in $\mu\text{mol H}_2\text{O}_2$ equiv./L.

$$P2 - P1 = P \text{ for standard or sample} \quad (1)$$

$$\text{TOS} = \frac{P \text{ sample}}{P \text{ standard}} \times 10 (\text{concentration of standard}) \quad (2)$$

The standard solution for the TAS assay was 1 mmol/L Trolox. In TAS measurements, 18 μL of standard solution, sample, or distilled water was duplicated into a 96-well plate. Subsequently, 300 μL of Reagent 1 containing 0.4 mol/L acetate buffer (pH 5.8; Diagnostic Assay Rail, Turkey) was added to each well. After the mixture was mixed, P1 was read using a SpectraMax Plus 384 Microplate spectrophotometer machine (Molecular Devices, CA, USA) at a wavelength of 660 nm. About 45 μL of Reagent 2 containing 30 mmol/L 2,2'-azinobis (3-ethylbenzo- tiyazolin-6-sulfonik acid) prochromogen solution was added to each well. P2 was read after 10 min of incubation at room temperature. Subsequently, the absorption of each sample was calculated by using formula 3. TAS was calculated according to formula 4 and reported in mmol Trolox equiv./L.

$$P2 - P1 = P \text{ for standard, sample or distilled water} \quad (3)$$

$$\text{TAS} = \frac{P \text{ distilled water} - P \text{ sample}}{P \text{ distilled water} - P \text{ standard}} \quad (4)$$

Evaluation of 8-OHdG status by direct immunofluorescence of the testis

Serial sections of paraffin-embedded right testis of 3- μm thickness were prepared. The tissue sections were then mounted on the poly-L-lysine slides (Thermo Scientific, USA), dried, deparaffinized in double series xylene (Epredia, USA), and rehydrated in graded alcohols (Cancer Diagnostic, Inc., the UK). This step was followed by heating the tissue sections in a microwave oven in pre-heated 10mM sodium citrate (Sigma Aldrich, Germany) buffer (pH 6.0) for 5 min for antigen retrieval. Subsequently, permeabilization was carried out using 0.1% Triton- \times 100 (Scharlau, Barcelona) in PBS (ThermoFisher Scientific, USA) for 30 min. The slides were washed

three times with PBS before incubation in Blocking One Solution (Nacalai Tesque, Kyoto, Japan) for 10 min. This was used to inhibit non-specific binding. Before overnight incubation with mouse monoclonal 8-OHdG (E8) antibody conjugated with Alexa Fluor 488 (1:100) (Santa Cruz Biotechnology, Texas, USA) at 4 °C, the slides were rewashed with PBS (ThermoFisher Scientific, USA) three times.

Following antibody binding, the slides were washed three times with PBS (ThermoFisher Scientific, USA). Subsequently, 10 µg/mL Hoechst 33342 (Sigma Aldrich, Germany) was used to counterstain the DNA. The final 8-OHdG staining was observed by using Nikon Eclipse Ni fluorescent microscope (Nikon, Japan) under 400× magnification. About 10 - 15 random fields were captured using Nikon Y-T TV (Nikon, Japan). The intensity of the staining from 20 random seminiferous tubules was measured using Image J software v1.52a (Rasband, W.S., USA). Steps were repeated for rectum adenocarcinoma tissue ⁽²⁰⁾ as a staining positive control.

Evaluation of sperm parameters

Sperm concentration

A 10 µL drop of sperm suspension was placed on Makler Chamber (Sefi Medical Instruments Ltd. Haifa, Israel). Sperm concentration was counted as an average of five rows under 10× magnification of a brightfield microscope (Olympus CH-2, Japan).

Sperm motility

Sperm motility was determined according to the World Health Organization (WHO) ⁽²¹⁾ recommendations. Sperm motility was categorized into three categories: (A) progressive motile sperm, (B) non-progressive motile sperm and, (C) immotile sperm. A 10 µL drop of sperm suspension was placed on a microscope slide and cover slipped. A total of 200 cells were counted in duplicate under a 40× magnification bright-field microscope (Olympus CH-2, Japan). Sperm motility was reported as percentage of total motile sperm $(A + B / \text{total counted sperm}) \times 100$.

Sperm viability

Sperm viability was evaluated by using the hypo-osmotic swelling test. The hypo-osmotic swelling solution was prepared by adding 0.735 g sodium citrate dehydrate (Sigma Aldrich, Germany) and 1.351 g d-fructose (Sigma Aldrich, Germany) in 100 mL of distilled water.

The sperm suspension from the cauda epididymis was mixed with a hypo-osmotic swelling solution in a ratio of 1:10. The mixture was incubated at 37°C for 30 min. About 10 µL from the mixture was placed on a microscope slide, smeared and left to dry at room temperature.

To enhance the visibility of the sperm under bright field microscope visualization, the smear was

stained with Diff Quick staining where the slides were dipped in Diff Quick Fix, Diff Quick 1, and Diff Quick II (Thermo Fisher Scientific, USA) for 5 min. Thereafter, the slides were rinsed, and dried at room temperature. The viable sperm were then counted under 40× magnification out of 200 sperm cells. Counting was carried out in duplicate.

Sperm morphology

About 50 µL of the sperm sample was mixed with 50 µL eosin-nigrosin (Sigma Aldrich, Germany) staining solution and incubated for 30 s at room temperature. Subsequently, 10 µL of the mixture was placed on a glass slide and smeared. After the smear was dry, the slide was observed under a light microscope with 100× magnification. Sperm morphology was assessed through the shape of the head, midpiece, and sperm tail and the presence of cytoplasmic debris. The percentage of sperm morphology was determined by counting at least 200 sperm in duplicate for each slide.

Sperm chromatin integrity

The status of sperm chromatin integrity was assessed by toluidine blue (TB) staining, a cytochemical test that is sensitive for sperm chromatin condensation and DNA integrity evaluation ⁽²²⁾. TB staining 0.05% (Sigma Aldrich, Germany) was prepared in McIlvain (pH 3.5) buffer. First, a 10 µL drop of sperm sample was placed and smeared on a slide. After the smear was dry, the slides were transferred into a fixation solution of ethanol: acetone 96% (1:1; JT Baker, USA) at 4 °C for 30 min. The slides were transferred into 0.1 N hydrochloric acid (Sigma Aldrich, Germany) and incubated at 4 °C for another 5 min. Following the hydrolysis step, slides were immersed for 2 min in distilled water, and this rinsing step was performed three times.

TB staining was continued by transferring the slide into a 0.05% TB (Sigma Aldrich, Germany) staining solution for 10 min. The slides were then rinsed with distilled water and allowed to dry before observation under a light microscope (Olympus CH-2, Japan) under 100× magnification. Score 0 was given to sperm with light blue staining which indicates that the sperm contain normal chromatin integrity and denotes TB negative staining (TB-). Scores 1 and 2 refer to sperm with abnormal chromatin integrity, which were stained as dark blue and violet, respectively. Scores 1 and 2 were denoted as TB positive (TB+) ⁽²²⁾. At least 200 sperm were counted to obtain the percentage of sperm DNA damage status.

Statistical analysis

Statistical analysis was performed using SPSS version 22.0 software (SPSS Inc., Chicago, IL, USA). One-way analysis of variance (ANOVA) followed by Tukey's post-hoc analysis. The Kruskal-Wallis H test was used to evaluate immunofluorescence intensity

due to the lack of normality in the data distribution. A p-value of <0.05 was considered statistically significant.

RESULT

TOS and TAS in the testis

Measurement of TOS in the testis homogenate demonstrated that the Wi-Fi group exhibited a significant increase in TOS ($1606.06 \mu\text{mol H}_2\text{O}_2 \text{equiv./L} \pm 667.42$) compared with the control ($0.00 \mu\text{mol H}_2\text{O}_2 \text{equiv./L} \pm 0.00$, $p < 0.001$), sham Wi-Fi ($440.00 \mu\text{mol H}_2\text{O}_2 \text{equiv./L} \pm 23.8$, $p < 0.001$) and control EBN group ($4.87 \mu\text{mol H}_2\text{O}_2 \text{equiv./L} \pm 5.4$, $p < 0.001$). By contrast, supplementation of 250 mg/kg EBN to the Wi-Fi+EBN group led to a significant decrease in TOS ($24.66 \mu\text{mol H}_2\text{O}_2 \text{equiv./L} \pm 16.85$, $p < 0.001$) compared with the Wi-Fi group (figure 2A).

The TOS increment findings in the testis were consistent with the decrease in TAS following Wi-Fi exposure. In these findings, the reduction in TAS in the Wi-Fi group ($0.13 \text{ mmol Trolox equiv./L} \pm 0.08$) was significant compared with that in the control ($2.53 \text{ mmol Trolox equiv./L} \pm 0.12$, $p < 0.001$) and sham Wi-Fi groups ($2.83 \text{ mmol Trolox equiv./L} \pm 0.06$, $p < 0.001$). Supplementation of 250 mg/kg EBN to the Wi-Fi+EBN group demonstrated no significant changes in TAS ($0.46 \text{ mmol Trolox equiv./L} \pm 0.22$, $p > 0.05$; figure 2B).

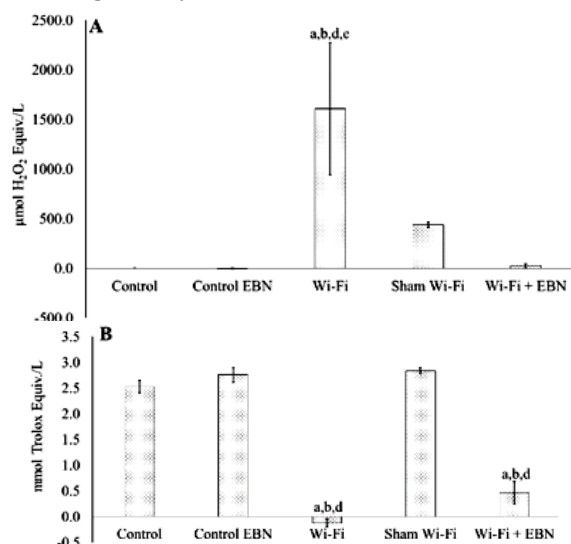

Figure 2. (A) Total oxidant status (TOS) in the testis. Data were reported as mean \pm SEM with $n = 6$ for each study group. a showed a significant difference compared with the control group, b showed a significant difference compared with the EBN control group, d showed a significant difference compared with the sham Wi-Fi group and e showed a significant difference compared with the Wi-Fi + EBN group. (B) Total antioxidant status (TAS) in the testis. Data were reported as mean \pm SEM with $n = 6$ for each study group. a showed a significant difference compared with the control group, b showed a significant difference compared with the EBN control group and c showed significant difference compared with the sham Wi-Fi group.

The 8-OHdG expression in the testis

The expression of 8-hydroxy-2'-deoxyguanosine (8-OHdG) in the testis was evaluated to confirm the presence of oxidative stress in the testis due to Wi-Fi exposure. In the Wi-Fi group, immunofluorescence staining revealed a significant increase in 8-OHdG expression in the testis. However, in the Wi-Fi + EBN group, supplementation with 250 mg/kg EBN resulted in a substantial decrease in 8-OHdG expression (figure 3).

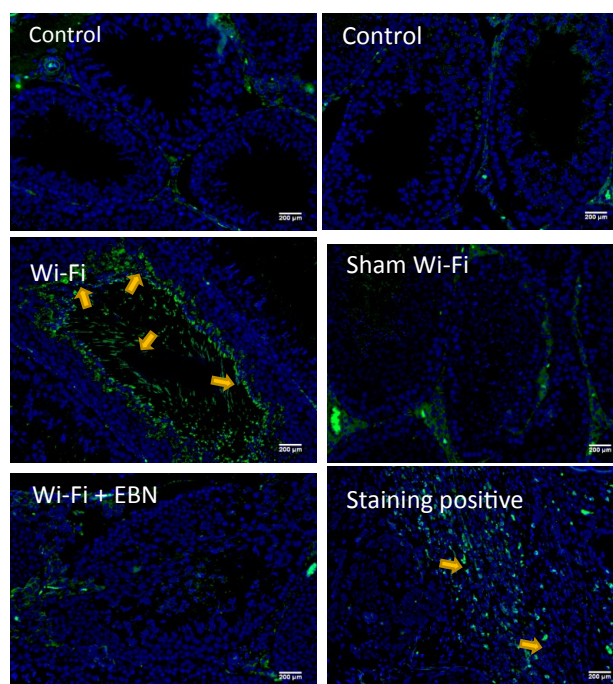

Figure 3. Immunofluorescence staining on sections of the testis for the expression of 8-OHdG by using Alexa Flour 488, with excitation and emission wavelengths of 490 and 525 nm, respectively. Positive staining is represented by green fluorescence signal (arrow). (a) Control group (b) control EBN group (c) Wi-Fi group (d) sham Wi-Fi group (e) Wi-Fi + EBN group, and (f) staining positive control by using rectum adenocarcinoma tissue section. For each section, Hoechst 33342 was used to counterstain the cell nuclei, as indicated by the blue signal. All observations were conducted under 200 \times magnification.

Kruskal-Wallis H analysis determined the significant differences in green immunofluorescent signal intensity measured by ImageJ software between groups (chi-square = 43.53, $p < 0.001$, $df = 4$). In this analysis, the Wi-Fi group showed the highest staining intensity among the tested group. At the same time, the intensity of green staining in the other groups remained low. Moreover, the administration of EBN in the Wi-Fi+EBN group decreased the expression of 8-OHdG in the testis (figure 4).

Evaluation of the Sperm Quality

Sperm concentration

Evaluation of the sperm concentration demonstrated that the Wi-Fi group ($59.1 \times 10^6/\text{mL} \pm 3.77$) showed a significant decrease in sperm

concentration compared with the control group ($94.4 \times 10^6/\text{mL} \pm 7.28$, $p < 0.001$) and sham Wi-Fi groups ($84.4 \times 10^6/\text{mL} \pm 2.02$, $p < 0.05$).

By contrast, the control EBN group ($134.0 \times 10^6/\text{mL} \pm 6.77$) showed a significant increase compared with the control group ($94.4 \times 10^6/\text{mL} \pm 7.28$, $p < 0.001$). Notably, EBN supplementation to the Wi-Fi+EBN group ($78.9 \times 10^6/\text{mL} \pm 3.28$) caused a significant increase in sperm concentration compared with the Wi-Fi group ($59.12 \times 10^6/\text{mL} \pm 3.77$, $p < 0.001$; figure 5A).

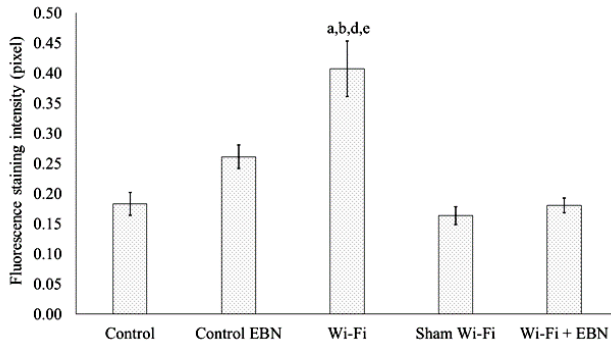

Figure 4. Green immunofluorescence intensity measured by Image J is presented as median \pm SEM ($n = 6$). The Kruskal-Wallis H test showed significant differences * among the groups (chi-square = 24.84, $p = 0.000$, $df = 2$).

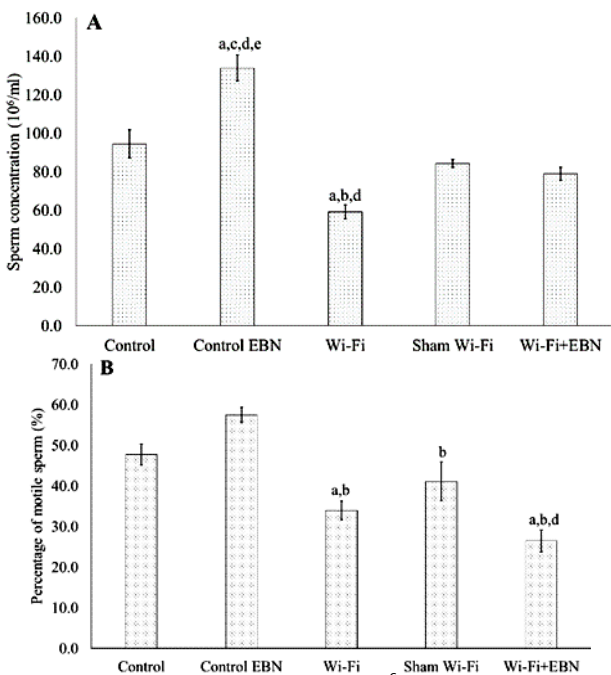

Figure 5. (A) Sperm concentration ($10^6/\text{mL}$) for each group. Data were reported as mean \pm SEM with $n=6$ for each group. a showed a significant difference compared with the control group, c showed a significant difference compared with the Wi-Fi group, d showed a significant difference compared with the sham Wi-Fi group, and e showed a significant difference compared with the Wi-Fi+ EBN group. # indicates a significant increase by T-test compared with the Wi-Fi group. **(B)** Percentage of motile sperm for each group. Data were reported as mean \pm SEM with $n=6$ for each group. a showed a significant difference compared with the control group, and b showed a significant difference compared with the EBN control group, and d showed a significant difference compared with the sham Wi-Fi group.

Sperm motility

A significant decrease also occurred in sperm motility parameters in the Wi-Fi group ($33.9\% \pm 2.31$) compared with the control group ($47.7\% \pm 2.55$, $p < 0.05$). Moreover, we found no significant increase in the percentage of motile sperm in the Wi-Fi+EBN group ($26.5\% \pm 2.66$, $p > 0.05$) compared with the Wi-Fi group ($33.9\% \pm 2.31$; figure 5B).

Sperm viability

Although the motility of the sperm was affected by Wi-Fi exposure, we found no significant decrease in the percentage of viable sperm in the Wi-Fi group ($22.3\% \pm 1.11$, $p > 0.05$) compared with the control group. Supplementation of EBN to the Wi-Fi+EBN group ($16.5\% \pm 1.25$, $p > 0.05$) also showed no significant increase compared with the Wi-Fi group.

Only the control EBN ($30.6\% \pm 1.72$) group showed a significant increase compared to the control ($19.1\% \pm 2.12$, $p < 0.001$), Wi-Fi ($22.3\% \pm 1.11$, $p = 0.005$), sham Wi-Fi ($17.7\% \pm 0.96$, $p < 0.001$) and Wi-Fi+EBN ($16.5\% \pm 1.25$, $p < 0.001$) groups (figure 6).

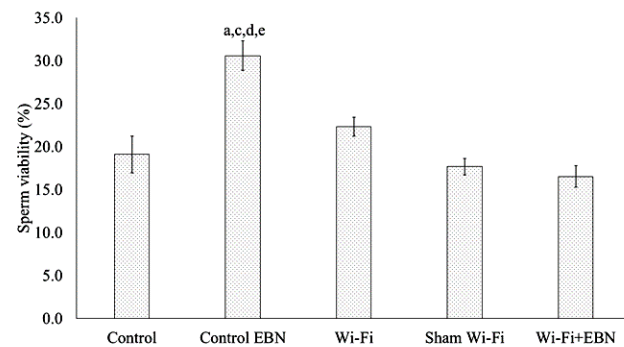

Figure 6. Percentage of viable sperm for each group. Data were reported as mean \pm SEM with $n=6$ for each group. a showed a significant difference compared with the control group. c showed a significant difference compared with the Wi-Fi group. d showed a significant difference compared with the sham Wi-Fi group. e showed a significant difference compared to the Wi-Fi + EBN group.

Sperm morphology

Exposure to Wi-Fi also affected the development of sperm morphology. Figure 7 shows that, the percentage of sperm with normal morphology was the lowest in the Wi-Fi group compared with the other groups. The comparison within each group was significant based on Kruskal-Wallis H analysis (Chi-square = 15.90, $p < 0.01$, $df = 4$).

At the same time, the supplementation of EBN in the Wi-Fi+EBN group restored the percentage of sperm with normal morphology to a level equivalent to the control group.

Sperm chromatin integrity

Besides affecting sperm morphology, long-term Wi-Fi exposure from pre-pubertal to adult age also caused a decrease in sperm chromatin integrity.

Figure 8 shows that, Wi-Fi exposure caused a reduction in the number of sperm with negative toluidine blue (TB) staining but an increase in positive TB staining. Negative TB staining represents the percentage of sperm with normal chromatin integrity, whereas TB positive represents sperm with impaired chromatin integrity.

The Kruskal–Wallis H test revealed there was a significant difference in negative TB (chi-square = 34.20, $p < 0.001$, $df = 4$) and positive TB staining (chi-square = 34.01, $p < 0.001$, $df = 4$) in the Wi-Fi group compared with the other groups.

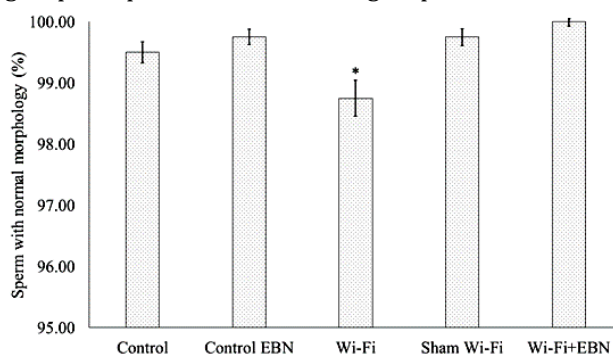

Figure 7. Percentage of sperm with normal morphology for each group. Data were reported as median \pm SEM with $n = 6$ for each group. The Kruskal–Wallis H test showed a significant difference marked with * between the Wi-Fi group and the other groups (chi square = 15.90, $p < 0.01$, $df = 4$).

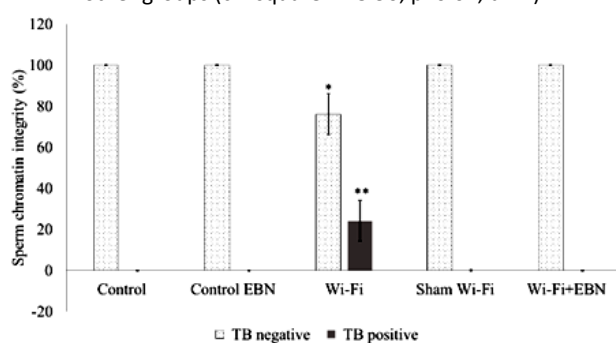

Figure 8. Percentage of sperm chromatin integrity for each group. Data were reported as median \pm SEM with $n = 6$ for each group. The Kruskal–Wallis H test showed a significant difference between the groups for TB negative * (chi square = 34.20, $p < 0.001$, $df = 4$) and TB positive ** (chi square = 34.01, $p < 0.001$, $df = 4$).

DISCUSSION

In this study, three-week-old Sprague Dawley male pups were continuously exposed to Wi-Fi for 14 weeks. As a result of this prolonged Wi-Fi exposure, total oxidant status (TOS) significantly increased, whereas total antioxidant (TAS) significantly decreased. The imbalanced state between TOS and TAS is defined as oxidative stress (23). Similar findings of the imbalance between oxidant and antioxidant following Wi-Fi exposure were reported previously in which the reactive oxygen species (ROS) and malondialdehyde (MDA) in the testis significantly

increased (7,8,24). At the same time, the antioxidant enzymes including superoxide dismutase (SOD) and glutathione peroxidase (GPx) were found to be reduced (7,24,25). Although the current findings were consistent with a previous report, the earlier investigation used adult animals, whereas the present study exposed the animals at a pre-pubertal stage. These comparable findings implied that excessive Wi-Fi use may result in the development of oxidative stress in the testis regardless of age. Given that young testis is still developing and may be vulnerable to the radiofrequency radiation (RFR) emitted by Wi-Fi devices, whether young testis is prone to have higher oxidative stress status than adults is unknown. Future research may compare adolescent and adult models to fully comprehend this knowledge gap.

How RFR as non-ionizing radiation can contribute to the development of oxidative stress upon Wi-Fi exposure remains unclear. Theoretically, the RFR emitted from Wi-Fi exposure can be absorbed into tissues. The absorption of RFR changes the dielectric properties of water molecules (26), induces collision and vibration, and generates heat (27). This generation causes a thermal effect. However, continuous absorption of this energy will further cause friction between the moving clusters of water molecules. This phenomenon causes the water to lose viscosity and partially undergo irreversible decomposition (28). As a result, the intracellular bond breakage will generate various ROS, particularly hydroxyl radical ($\text{HO}\cdot$) (27). Hydroxyl radicals have been reported to be the most aggressive form of ROS. The generation of ROS over time under Wi-Fi exposure may have led to oxidative stress in the testis of the exposed rat pups.

ROS such as $\text{HO}\cdot$, hydrogen peroxide (H_2O_2), and superoxide anions (O_2^-) has a very short half-life (29,30). Thus, ROS destruction in samples during analysis is unavoidable during analysis. Despite adopting TOS measurement kit recommendations to minimize ROS destruction, uncontrolled ROS destruction may still occur. This phenomenon resulted in a diversity of values, which caused a different average reading for each animal, contributing to the high standard error of the mean (SEM) value recorded in the Wi-Fi group.

The oxidative stress activity in the testis was further validated by the significant increase of 8-hydroxy-2'-deoxyguanosine (8-OHdG) expression in the Wi-Fi group. The obtained data were consistent with a previous study, which also found a rise in 8-OHdG expression in the serum and testis of adult Wistar Albino rats following 20 weeks of Wi-Fi exposure (9). As 8-OHdG is closely associated with disruption of chromatin remodeling (31,32), the increase in 8-OHdG expression in the testis of the Wi-Fi group might explain the noticeably high percentage of compromised chromatin integrity. Given that sperm morphology and sperm chromatin

integrity are closely connected to each other^(33,34), impairment of sperm chromatin integrity may explain the reduction in sperm with normal morphology in the Wi-Fi group. Furthermore, the current findings on the sperm chromatin integrity may shed light on the considerable rise in sperm DNA fragmentation after Wi-Fi exposure as frequently reported in previous studies^(35,36). Thus, the harm brought on by Wi-Fi exposure also resulted from non-thermal effects involving ROS activity.

Other than sperm chromatin integrity and sperm morphology changes, long-term Wi-Fi exposure from pre-pubertal to adult age also caused a significant decrease in sperm concentration and motility. Similar effects of Wi-Fi on sperm concentration^(3,7,25,37-39) and sperm motility^(7,33,39,40) were also reported in previous research. Although the decrease in sperm concentration was initially attributed to the thermal effect, the occurrence of oxidative stress in the testis also became a contributing factor. The spermatogonia mitotic status decreased even though the key protein regulators of spermatogonia mitosis, c-Kit and stem cell factor, did not significantly change following Wi-Fi exposure⁽⁵⁾. Thus, the occurrence of oxidative stress in the testis may have changed both protein structures rather than altering their expression. This notion is postulated in light of previous research that demonstrated elevated TOS-induced oxidative stress can result in protein degradation, lipid peroxidation, and DNA damage^(41,42). Occurrence of oxidative stress, which subsequently disrupts the protein structure, may eventually lead to a decrease in sperm concentration.

As for sperm motility, this sperm parameter is dependent on the fluidity of the sperm membrane, which in turn is dependent on the ratio of polyunsaturated fatty acids (PUFAs) to protein⁽⁴³⁾. As a result of the numerous double chains in the PUFAs, the sperm membrane is more vulnerable to ROS attack and ROS cascading effect. Oxidative stress in the testis following Wi-Fi exposure may cause sperm membranes to be strongly susceptible to oxidative damage, thereby impairing sperm membrane fluidity and causing the observed reduction of sperm motility in the Wi-Fi group.

Previous studies demonstrated that administering antioxidative supplements improves the oxidative stress status in the liver^(44,45) eye, testis, and erythrocyte⁽⁴⁶⁾ after exposure to RFR. Thus, this recent study adopted a similar approach by implementing the supplementation of 250 mg/kg EBN daily to the Wi-Fi + EBN group. Interestingly, EBN supplementation significantly reduced TOS. Despite the profound decrease in TOS, TAS did not significantly increase with EBN supplementation. This finding might be due to the antioxidants in EBN being utilized to ameliorate the elevated TOS activity by Wi-Fi exposure.

A decrease in 8-OHdG expression in the testis

after EBN supplementation in the Wi-Fi+EBN group further validated the ability of EBN to improve overall oxidative stress status. This result was due to the ROS activity that typically causes changes in the DNA bases, especially guanine, because it has the lowest oxidation potential of the four bases. Following the low oxidation potential of the guanine base, ROS, especially HO•, will cause oxidation of the guanine base. This oxidation will cause the formation of C8-hydroxyguanine (8-OHGua) or deoxyguanosine (8-hydroxy-2'-deoxyguanosine). With the rejection of one electron, 8-OHdG is formed⁽⁴⁷⁾. Therefore, low TOS activity indicated low ROS activity toward DNA bases and led to the low 8-OHdG formation in the Wi-Fi+EBN group. By significantly reducing 8-OHdG expression, the sperm chromatin integrity and sperm morphology in the Wi-Fi+EBN group, were preserved. Restoring the sperm chromatin integrity in an intact state may prevent aberrant genetic transmission to the next generation.

Furthermore, alleviating the oxidative stress status by supplementation of EBN to the Wi-Fi+EBN group significantly increased the sperm concentration. The increase in the sperm concentration was consistent with the increase in spermatogonia mitosis status in the Wi-Fi+EBN group documented previously⁽⁵⁾. In our previous report, the increase of the spermatogonia mitosis status was thought to be due to the changes in serum FSH level, but the results in this study suggested that the restoration of oxidative stress also played an additional factor in improving the overall mitosis status. Unfortunately, supplementation of EBN to the Wi-Fi+EBN group did not show any significant changes in sperm motility and sperm viability parameters compared with the Wi-Fi group.

Overall, these findings affirmed the antioxidative effect of EBN on the testis. According to Ghassem *et al.*⁽⁴⁸⁾, the protein hydrolysates in EBN are an excellent source of natural antioxidants. Most of the compounds discovered in the EBN employed in this study were amino acids⁽³⁾. As amino acids are the building blocks of protein, their presence could be the source of EBN's antioxidant capabilities. Previous reports also described the presence of vitamins A, C, and D⁽⁴⁹⁾. Although the role of vitamins A⁽⁵⁰⁾ and D⁽⁵¹⁾ as antioxidants remains controversial, vitamin C is well-known for its anti-oxidative effects⁽⁵²⁾.

Vitamin C, which is naturally present in high amounts in Sertoli cells and pachytene spermatocytes, helps maintain α -tocopherol in an active state⁽⁵³⁾. As Sertoli cells play a vital role in spermatogonia mitosis during spermatogenesis, the presence of vitamin C in EBN might contribute to the significant increase in sperm concentration in the Wi-Fi+EBN group⁽⁵⁾.

Other than vitamin C, previous elemental analysis of EBN demonstrated the presence of zinc⁽⁵⁴⁾, a core constituent of a free radical scavenging enzyme SOD

(53). By having such an essential antioxidant role, both vitamin C and zinc have a profound effect on the level of oxidative stress experienced by the testis, particularly in preventing lipid peroxidation. Thus, preservation of the lipid membrane, may ensure the integrity of the chromatin status and contribute to reducing 8-OHdG.

However, further research will be needed to identify the precise mechanism through which EBN enhances the antioxidant system in the testis after exposure to Wi-Fi. As EBN is a natural product of various complex compounds, more than one substance might have worked synergistically to produce the observed antioxidative effect. The isolation of EBN's active antioxidant substance and comparison to another known antioxidant could reveal the mechanism by which EBN played its antioxidative role.

CONCLUSIONS

In conclusion, the long-term exposure of developing rat pups to Wi-Fi throughout the pre-pubertal age to adulthood caused oxidative stress in the testis. EBN supplementation at a dose of 250 mg/kg per day in young rats that received Wi-Fi exposure demonstrated a positive discovery in reducing oxidative stress in the testis. Despite the recommendation to minimize Wi-Fi exposure hours, maintaining the antioxidant status quo as an additional preventive measure is advisable. On the basis of these findings, EBN supplementation demonstrated high potential in combating the effect of daily radiation coming from the current Wi-Fi technology. Positive proliferative effects, hormonal content, and antioxidant properties may help to overcome male fertility problems that are often multifaceted, especially in this digital era.

ACKNOWLEDGMENTS

Our greatest gratitude goes to Glycofood Sdn. Bhd. for providing the EBN extract. We would also like to thank all laboratory personnel who assisted with the animals' care and technical help during the molecular study.

Conflict of Interest: The authors declare no conflict of interest.

Ethical consideration: All animal procedures were ethically approved by the National University of Malaysia Animal Ethical Committee (UKMAEC) on March 28, 2018. This study's animal ethical approval reference number was FISIO/PP/2018/SITI FATI-MAH/28-MAR./908-MAR.-2018-DEC.-2020.

Funding: This research was funded by the Ministry of Education (MOE) of Malaysia (grant no. FRGS/1/2019/SKK06/UKM/02/3) and the Faculty of Medicine, UKM (grant no. FF-2018-193).

Author Contributions: FJ, SI, and KO designed the study. FJ and AZ conducted the data acquisition and, interpreted and analyzed the data. FJ drafted the manuscript. SI, KO, and CH revised the manuscript and supervised the whole work. All authors read and approved the final manuscript.

REFERENCES

- Sun W, Lee O, Shin Y, et al. (2014) Wi-Fi could be much more. *IEEE Commun Mag*, **52**:22-29.
- Kesari KK, Agarwal A, Henkel R (2018) Radiations and male fertility. *Reprod Biol Endocrinol*, **16**:118.
- Jaffar FHF, Osman K, Hui CK, et al. (2019) Adverse Effects of Wi-Fi Radiation on Male Reproductive System: A Systematic Review. *Tohoku J Exp Med*, **248**:169-179.
- Aldahhan RA and Stanton PG (2021) Heat stress response of somatic cells in the testis. *Mol Cell Endocrinol*, **527**:111216.
- Jaffar FHF, Osman K, Hui CK, Zulkefli AF, Ibrahim SF (2022) Long-Term Wi-Fi Exposure from Pre-Pubertal to Adult Age on the Spermatogonia Proliferation and Protective Effects of Edible Bird's Nest Supplementation. *Front Physiol*, **13**:1-11.
- Feng CW, Bowles J, Koopman P (2014) Control of mammalian germ cell entry into meiosis. *Mol Cell Endocrinol*, **382**:488-497.
- Shahin S, Mishra V, Singh SP, Chaturvedi CM (2014) 2.45-GHz microwave irradiation adversely affects reproductive function in male mouse, *Mus musculus* by inducing oxidative and nitrosative stress. *Free Radic Res*, **48**:511-525.
- Saygin M, Asci H, Ozmen O, et al. (2016) Impact of 2.45GHz microwave radiation on the testicular inflammatory pathway biomarkers in young rats: the role of gallic acid. *Environ Toxicol*, **31**: 1771-1784.
- Atasoy HI, Gunal MY, Atasoy P, et al. (2019) Immunohistopathologic demonstration of deleterious effects on growing rat testes of radiofrequency waves emitted from conventional Wi-Fi devices. *J Pediatr Urol*, **9**:223-229.
- Kovačić Petrović Z, Peraica T, Kozarić-Kovačić D, Palavra IR (2022) Internet use and internet-based addictive behaviours during coronavirus pandemic. *Curr Opin Psychiatry*, **35**:324-331.
- Quek MC, Chin NL, Yusof YA, et al. (2018) Characterization of edible bird's nest of different production, species and geographical origins using nutritional composition, physicochemical properties and antioxidant activities. *Food Res Int*, **109**:35-43.
- Wang CY, Cheng LJ, Shen B, et al. (2019) Antihypertensive and Antioxidant Properties of Sialic Acid, the Major Component of Edible Bird's Nests. *Curr Top Nutraceutical Res*, **17**:376-379.
- Kuntjoro S and Rachmadiarti F (2020) Preference swiftlet bird (*Aerodramus fuciphagus*) nesting at different sites in an effort to increase nest production. *J Phys: Conf Ser*, **1569**:1-6.
- Thorburn C (2014) The edible birds' nest boom in Indonesia and South-east Asia: a nested political ecology. *Food Cult Soc*, **17**:535-553.
- Saygin M, Asci H, Ozmen O, et al. (2015) Impact of 2.45 GHz microwave radiation on the testicular inflammatory pathway biomarkers in young rats: The role of gallic acid. *Environ Toxicol*, **31**: 1771-1784.
- Ding SS, Sun P, Zhang Z, et al. (2018) Moderate dose of trolox preventing the deleterious effects of Wi-Fi radiation on spermatozoa in vitro through reduction of oxidative stress damage. *Chin Med J*, **131**:402-412.
- Jamshid M and Bahram P (2018) Effect of hydroalcoholic extract of *nasturtium officinalis* on oxidative and antioxidant indices caused by electromagnetic radiation emitted from wi-fi routers. *J Fundam Appl Sci*, **10**: 464-474.
- Jaffar FHF, Osman K, Hui CK, et al. (2021) Edible bird's nest supplementation improves male reproductive parameters of sprague dawley rat. *Front Pharmacol*, **12**:1-6.
- Koksal M, Oğuz E, Baba F, et al. (2012) Effects of melatonin on testis histology, oxidative stress and spermatogenesis after experimental testis ischemia-reperfusion in rats. *Eur Rev Med Pharmacol Sci*, **16**:582-588.
- Kim MJ, Kwon MJ, Kang HS, et al. (2018) Identification of Phosphohistone H3 cut off values corresponding to original WHO grades but distinguishable in well-differentiated gastrointestinal neuroendocrine tumors. *Biomed Res Int*, **2018**:1-10.

21. World Health Organization (2010) WHO Laboratory Manual for the Examination and Processing of Human Semen. 5th ed. WHO Press, Geneva, Switzerland.
22. Rahimipour M, Talebi AR, Anvari M, et al. (2013) Effects of different doses of ethanol on sperm parameters, chromatin structure and apoptosis in adult mice. *Eur J Obstet Gynecol Reprod Biol*, **170**: 423-428.
23. Pizzino G, Irrera N, Cucinotta M, et al. (2017) Oxidative stress: harms and benefits for human health. *Oxid Med Cell Longev*, **2017**:1-13.
24. Jonwal C, Sisodia R, Saxena VK, Kesari KK (2018) Effect of 2.45 GHz microwave radiation on the fertility pattern in male mice. *Gen Physiol Biophys*, **37**:453-460.
25. Kesari KK and Behari J (2010) Effects of microwave at 2.45 GHz radiations on reproductive system of male rats. *Toxicol Environ Chem*, **92**:135-1147.
26. Behari J (2010) Biological responses of mobile phone frequency exposure. *Indian J Exp Biol*, **48**: 959-981.
27. Ramaswamy H and Tang J (2010) Microwave and radio frequency heating. *Food Sci Technol Int*, **14**:423-427.
28. Yakymenko I, Tsybulin O, Sidorik E, et al. (2015) Oxidative mechanisms of biological activity of low-intensity radiofrequency radiation. *Electromagn Biol Med* **35**:186-202.
29. Dharmaraja AT and Chakrapani H (2014) A small molecule for controlled generation of reactive oxygen species (ROS). *Org Lett*, **16**:398-401.
30. Agarwal A, Gupta S, Sharma R (2016) Reactive oxygen species (ROS) measurement. In: *Andrological Evaluation of Male Infertility*, (Agarwal A, Gupta S, Sharma R, eds.), Springer, Cham, Switzerland.
31. De Iullis GN, Thomson LK, Mitchell LA, et al. (2009) DNA damage in human spermatozoa is highly correlated with the efficiency of chromatin remodeling and the formation of 8-hydroxy-2'-deoxyguanosine, a marker of oxidative stress. *Biol Reprod*, **81**:517-524.
32. Sharma R, Martinez MP, Agarwal A (2020) Sperm chromatin integrity tests and indications. In: *Male Infertility*, (Parekattil S, Esteves S, Agarwal A. eds.), Springer, Cham, Switzerland.
33. Alipour F, Jalali M, Nikravesh MR, et al. (2018) Assessment of sperm morphology, chromatin integrity, and catSper genes expression in hypothyroid mice. *Acta Biol Hung*, **69**:244-258.
34. Pourmasumi S, Khoradmehr A, Rahiminia T, et al. (2019) Evaluation of sperm chromatin integrity using aniline blue and toluidine blue staining in infertile and normozoospermic men. *J Reprod Infertil*, **20**:95-101.
35. Avendaño C, Mata A, Sarmiento CAS, Doncel GF (2012) Use of laptop computers connected to internet through Wi-Fi de-creases human sperm motility and increases sperm DNA fragmentation. *Fertil Steril*, **97**:39-45.e2.
36. Ding SS, Ping S, Hong T (2018) Association between daily exposure to electromagnetic radiation from 4G smartphone and 2.45 GHz Wi-Fi and oxidative damage to semen of males attending a genetics clinic: a primary study. *Int J Clin Exp Med*, **11**:2821-2830.
37. Saygin M, Caliskan S, Karahan N, et al. (2011) Testicular apoptosis and histopathological changes induced by a 2.45 GHz electromagnetic field. *Toxicol Ind Health*, **27**:455-463.
38. Mahmoudi R, Mortazavi S, Safari S, et al. (2015) Effects of microwave electromagnetic radiations emitted from common Wi-Fi routers on rats' sperm count and motility. *Int J Radiat Res*, **13**:363-368.
39. Shokri S, Soltani A, Kazemi M, et al. (2015) Effects of Wi-Fi (2.45 GHz) exposure on apoptosis, sperm parameters and testicular histomorphometry in rats: a time course study. *Cell J*, **17**:322-331.
40. Dasdag S, Taş M, Akdag MZ, Yegin K (2015) Effect of long-term exposure of 2.4 GHz radiofrequency radiation emitted from Wi-Fi equipment on testes functions. *Electromagn Biol Med*, **34**:37-42.
41. Minutoli L, Puzzolo D, Rinaldi M, et al. (2016) ROS-mediated NLRP3 inflammasome activation in brain, heart, kidney, and testis ischemia/reperfusion injury. *Oxid Med Cell Longev*, **2016**:1-10.
42. Yi W, Xiang-Liang T, Yu Z, et al. (2018) DEHP exposure destroys blood testis barrier (BTB) integrity of immature testes through excessive ROS mediated autophagy. *Genes Dis*, **5**:263-274.
43. Naz T, Chakraborty S, Saha S (2022) Role of fatty acids and calcium in male Reproduction. *Reprod Dev Med*, **6**:57-64.
44. Ozmen O and Kavrik O (2020) Ameliorative effects of vitamin C against hepatic pathology related to Wi-Fi (2.45 GHz electromagnetic radiation) in rats. *Int J Radiat Res*, **18**:405-412.
45. Moradpour R, Shokri M, Abedian S, et al. (2020) The protective effect of melatonin on liver damage induced by mobile phone radiation in mice model. *Int J Radiat Res*, **18**:133-141
46. Jelodar G, Akbari A, Parvaei P, Nazii S (2018) Vitamin E protects rat testis, eye and erythrocyte from oxidative stress during exposure to radiofrequency wave generated by a BTS antenna model. *Int J Radiat Res*, **16**:217-224.
47. Valavanidis A, Vlachogianni T, Fiotakis C (2009) 8-hydroxy-2'-deoxyguanosine (8-OHdG): a critical biomarker of oxidative stress and carcinogenesis. *J Environ Sci Health C*, **27**:120-139.
48. Ghassem M, Arihara K, Mohammadi S, et al. (2017) Identification of two novel antioxidant peptides from edible bird's nest (*Aerodramus fuciphagus*) protein hydrolysates. *Food Funct*, **8**:2046-2052.
49. Lu Y, Han DB, Wang JY, et al. (1995) Study on The Main Ingredients of The Three Species of Edible Swift's Nest of Yunnan Province. *Zool Res*, **16**:385-391.
50. Blaner WS, Shmarakov IO, Traber MG (2021) Vitamin A and vitamin E: Will the real antioxidant please stand up? *Annu Rev Nutr*, **41**:105-131.
51. Tagliaferri S, Porri D, De Giuseppe R, et al. (2019) The controversial role of vitamin D as an anti-oxidant: results from randomised controlled trials. *Nutr Res Rev*, **32**:99-105.
52. Nowak D, Gośliński M, Wojtowicz E, Przygoński K (2018) Antioxidant properties and phenolic compounds of vitamin C-rich juices. *J Food Sci*, **83**:2237-2246.
53. Aitken RJ and Roman SD (2008) Antioxidant systems and oxidative stress in the testes. *Oxid Med Cell Longev*, **1**:15-24.
54. Looi QH and Omar AR (2016) Swiftlets and edible bird's nest industry in Asia. *PJSRR* **2**:32-48.